

Display CARFAX in online listings:



Vehicle History Report™

US \$44.99

2011 MAZDA MAZDA3 I SPORT

VIN: JM1BL1UF0B1419421
SEDAN 4 DR
2.0L I4 F DOHC 16V
GASOLINE
FRONT WHEEL DRIVE

This CARFAX Report Provided
by:
**MWR Auto Skills Center at
Hickam**



Minor to moderate damage

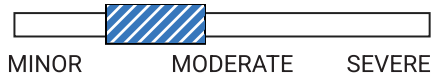

16 Service history records



6 Previous owners



Types of owners: Rental, Personal



145,594 Last reported odometer reading



This CARFAX Vehicle History Report is based only on information supplied to CARFAX and available as of 1/29/26 at 2:56:23 PM (CST). Other information about this vehicle, including problems, may not have been reported to CARFAX. Use this report as one important tool, along with a vehicle inspection and test drive, to make a better decision about your next used car.



Accident / Damage History

Not all accidents / issues are reported to CARFAX

Event 1

04/14/2016

**Damage reported: minor
to moderate damage**

Damage Severity Scale

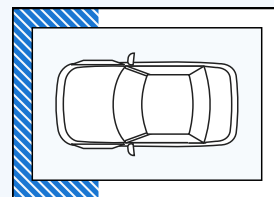
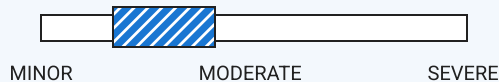

Event 2

01/29/2019

Damage reported: minor damage

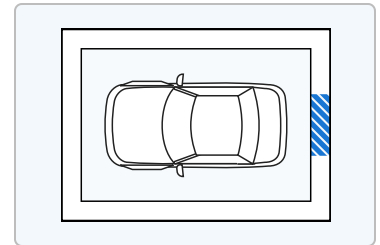
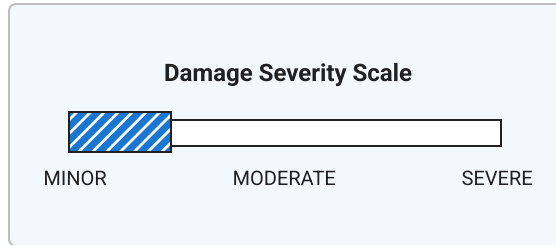

CARFAX Additional History Not all accidents / issues are reported to CARFAX	Owners 1-4	Owner 5	Owner 6
Total Loss No total loss reported to CARFAX.	✓ No Issues Reported	✓ No Issues Reported	✓ No Issues Reported
Structural Damage CARFAX recommends that you have this vehicle inspected by a collision repair specialist.	✓ No Issues Reported	✓ No Issues Reported	✓ No Issues Reported
Airbag Deployment No airbag deployment reported to CARFAX.	✓ No Issues Reported	✓ No Issues Reported	✓ No Issues Reported
Odometer Check No indication of an odometer rollback.	✓ No Issues Indicated	✓ No Issues Indicated	✓ No Issues Indicated
Accident / Damage Damage reported: 04/14/2016 and 01/29/2019.	Damage Reported	No New Issues Reported	No New Issues Reported
Manufacturer Recall No open recalls reported to CARFAX.	✓ No Recalls Reported	✓ No Recalls Reported	✓ No Recalls Reported
Basic Warranty Original warranty estimated to have expired.	Warranty Expired	Warranty Expired	Warranty Expired

CARFAX Title History CARFAX guarantees the information in this section	Owners 1-4	Owner 5	Owner 6
Damage Brands Salvage Junk Rebuilt Fire Flood Hail Lemon	✓ Guaranteed No Problem	✓ Guaranteed No Problem	✓ Guaranteed No Problem
Odometer Brands Not Actual Mileage Exceeds Mechanical Limits	✓ Guaranteed No Problem	✓ Guaranteed No Problem	✓ Guaranteed No Problem



GUARANTEED - None of these title problems were reported by a U.S. state Department of Motor Vehicles (DMV). If you find that any of these title problems were reported by a DMV and not included in this report, you may qualify.
View Terms | View Certificate



Ownership History

The number of owners is estimated

	Owners 1-4	Owner 5	Owner 6
Year purchased	2011	2021	2023
Type of owner	See Details	Personal	Personal
Estimated length of ownership	10 yrs. 6 mo.	2 yrs. 4 mo.	2 yrs. 1 mo.
Owned in the following states/provinces	See Details	Hawaii	Hawaii
Estimated miles driven per year	See Details	8,462/yr	---
Last reported odometer reading	123,248	142,650	145,594



Detailed History



Owner 1

Purchased: 2011

Rental Vehicle

Date	Mileage	Source	Comments
12/22/2010		NICB	Vehicle manufactured and shipped to California
01/10/2011	6	Hawaii Motor Vehicle Dept. Kailua Kona, HI Title #HMH58211	Vehicle purchase reported - Title issued or updated - Registration issued or renewed - First owner reported - Titled or registered as rental vehicle - Vehicle color noted as Gray
11/10/2011		Hawaii Motor Vehicle Dept. Kailua Kona, HI Title #HMH58211	Registration issued or renewed - Title or registration issued - Loan or lien reported - Vehicle color noted as Gray
12/19/2011		Hawaii Motor Vehicle Dept. Kailua Kona, HI Title #HMH58211	Title or registration issued - Loan or lien reported - Vehicle color noted as Gray



Owner 2

Purchased: 2012



Low mileage! This owner drove less than the industry average of 15,000 miles per year.

Personal Vehicle
10,449 mi/yr

Date	Mileage	Source	Comments
06/19/2012	26,775	Hawaii	Registration issued or renewed

Motor Vehicle Dept.
Laie, HI
Title #ZAC51312

- Title or registration issued
- New owner reported
- Loan or lien reported
- Vehicle color noted as Gray

10/23/2012 30,872

JN Automotive Group
Honolulu, HI
808-377-4670
jnmazda.com/

★ 3.7 / 5.0
53 Verified Reviews
♥ 1 Customer Favorite



Vehicle serviced

- Maintenance inspection completed
- Battery/charging system checked
- Brakes checked
- No-start/hard start condition checked
- Tire condition and pressure checked

10/31/2012 30,873

Honda Windward
Kaneohe, HI
808-247-8544
hondawindward.com

★ 4.8 / 5.0
1,528 Verified Reviews
♥ 3,107 Customer Favorites



Vehicle serviced

- A/C refrigerant recharged

01/04/2013

Hawaii
Motor Vehicle Dept.
Honolulu, HI
Title #ZAC51312

Title issued or updated

- Title or registration issued
- Loan or lien reported
- Registration updated when owner moved the vehicle to a new location
- Vehicle color noted as Gray

05/24/2013 36,489

Midas
Honolulu, HI
808-841-7361
midas.com

★ 4.8 / 5.0
69 Verified Reviews
♥ 82 Customer Favorites



Vehicle serviced

- Oil and filter changed
- Safety inspection performed

07/23/2013

Hawaii
Motor Vehicle Dept.
Honolulu, HI
Title #ZAC51312

Registration issued or renewed

- Loan or lien reported
- Vehicle color noted as Gray

01/17/2014

Hawaii
Motor Vehicle Dept.
Honolulu, HI
Title #ZAC51312

Title issued or updated

- Title or registration issued
- Loan or lien reported
- Vehicle color noted as Gray

03/19/2014 44,024

Lex Brodie's Tire
Company
Honolulu, HI
808-369-8410
lexbrodies.com

★ 4.7 / 5.0
1,322 Verified Reviews



Vehicle serviced

- Tire repaired

 **6,762** Customer Favorites

05/03/2014 45,240

Midas
Honolulu, HI
808-841-7361
midas.com

 **4.8 / 5.0**

69 Verified Reviews

 **82** Customer Favorites



Vehicle serviced

- Oil and filter changed
- Safety inspection performed
- Tires rotated

05/04/2014

Hawaii
Motor Vehicle Dept.
Honolulu, HI
Title #ZAC51312

Registration issued or renewed

- Loan or lien reported
- Vehicle color noted as Blue

10/07/2014 50,823

Lex Brodie's Tire
Company
Honolulu, HI
808-369-8410
lexbrodies.com

 **4.7 / 5.0**

1,322 Verified Reviews

 **6,762** Customer Favorites



Vehicle serviced

- Alignment performed

 **Owner 3**
Purchased: 2015

Personal Vehicle

Date	Mileage	Source	Comments
------	---------	--------	----------

04/28/2015

Hawaii
Motor Vehicle Dept.
Kaneohe, HI
Title #ZAC51315

Title issued or updated

- Title or registration issued
- New owner reported
- Vehicle color noted as Blue

06/06/2015

Hawaii
Motor Vehicle Dept.
Kaneohe, HI
Title #ZAC51315

Registration issued or renewed

- Vehicle color noted as Blue

12/10/2015

Hawaii
Motor Vehicle Dept.
Kaneohe, HI
Title #ZAC51315

Title issued or updated

- Title or registration issued

04/14/2016



Damage Report

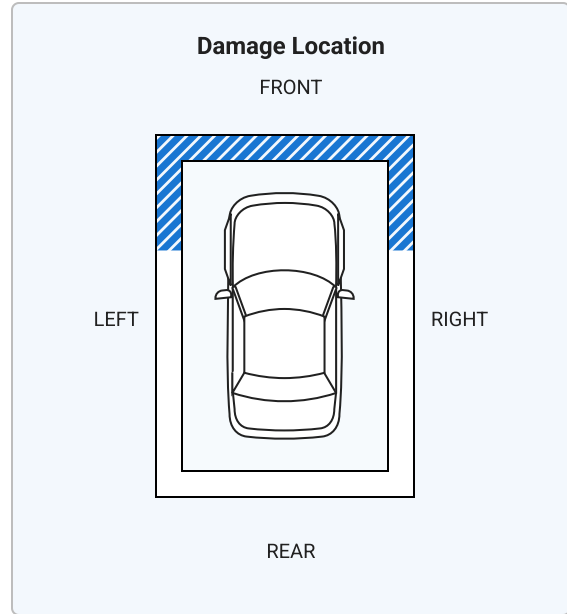
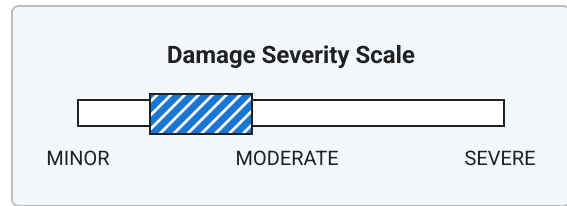

Damage reported: minor to moderate damage

- Damage to front
- Damage to left front
- Damage to right front



06/18/2016	Hawaii Motor Vehicle Dept. Kaneohe, HI Title #ZAC51315	Registration issued or renewed - Vehicle color noted as Blue
12/20/2016	Hawaii Motor Vehicle Dept. Kaneohe, HI Title #ZAC51315	Title issued or updated - Title or registration issued - Vehicle color noted as Blue
05/17/2017 82,081	Lex Brodie's Tire Company Kaneohe, HI 808-792-4900 ★ 4.8 / 5.0 604 Verified Reviews ❤️ 3,271 Customer Favorites	 Vehicle serviced - Maintenance inspection completed - Brake fluid flushed/changed - Front brake rotor(s) replaced - Front brakes serviced
08/12/2017 85,705	Lex Brodie's Tire Company Kaneohe, HI 808-792-4900 ★ 4.8 / 5.0 604 Verified Reviews ❤️ 3,271 Customer Favorites	 Vehicle serviced - Emissions or safety inspection performed
08/13/2017	Hawaii Motor Vehicle Dept. Kaneohe, HI	Registration issued or renewed - Vehicle color noted as Blue

Title #ZAC51315

12/12/2017

Hawaii
Motor Vehicle Dept.
Kaneohe, HI
Title #ZAC51315

Title or registration issued
- Vehicle color noted as Blue





Owner 4

Purchased: 2018



Low mileage! This owner drove less than the industry average of 15,000 miles per year.

Personal Vehicle
10,843 mi/yr

Date	Mileage	Source	Comments
01/11/2018		Hawaii Motor Vehicle Dept. Kaneohe, HI Title #ZAC51315	Title or registration issued - New owner reported - Vehicle color noted as Blue
04/09/2018	93,390	Discount Tire Honolulu, HI 808-836-0475 discounttirehawaii.com/ ★ 4.9 / 5.0 96 Verified Reviews ♥ 28 Customer Favorites	 Vehicle serviced - Tire condition and pressure checked - Tire valve stem(s)/core(s) replaced - Tire(s) balanced - Tire(s) mounted - Tire(s) replaced
04/12/2018		Hawaii Motor Vehicle Dept. JBPHH, HI Title #ZAC51318	Title issued or updated - Title or registration issued - Vehicle color noted as Blue
05/06/2018	93,985	Sears Auto Center Aiea, HI 808-487-4390 searsauto.com ★ 4.4 / 5.0 163 Verified Reviews	 Vehicle serviced - Maintenance inspection completed - Battery/charging system checked - Serpentine belt replaced - Tire condition and pressure checked
08/21/2018		Hawaii Motor Vehicle Dept. JBPHH, HI Title #ZAC51318	Registration issued or renewed - Vehicle color noted as Blue
12/04/2018		Hawaii Motor Vehicle Dept. JBPHH, HI Title #ZAC51318	Title issued or updated - Title or registration issued - Vehicle color noted as Blue
01/29/2019		Damage Report	 Damage reported: minor damage - Damage to rear

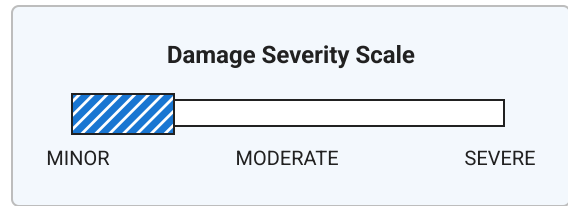

09/03/2019	Hawaii Motor Vehicle Dept. JBPHH, HI Title #ZAC51318	Registration issued or renewed - Vehicle color noted as Blue
12/23/2019	Hawaii Motor Vehicle Dept. JBPHH, HI Title #ZAC51318	Title or registration issued - Vehicle color noted as Blue
01/08/2021	123,248 Oil Changers Waipahu, HI 808-678-1192 https://oilchangers.com/ ★ 4.8 / 5.0 427 Verified Reviews ❤️ 147 Customer Favorites	 Vehicle serviced - Emissions or safety inspection performed
01/08/2021	Hawaii Motor Vehicle Dept. JBPHH, HI Title #ZAC51318	Title issued or updated - Title or registration issued - Vehicle color noted as Blue
03/19/2021	Hawaii Motor Vehicle Dept. JBPHH, HI Title #ZAC51318	Registration issued or renewed - Vehicle color noted as Blue







Owner 5

Purchased: 2021



Low mileage! This owner drove less than the industry average of 15,000 miles per year.

Personal Vehicle
8,462 mi/yr

Date	Mileage	Source	Comments
08/04/2021		Hawaii Motor Vehicle Dept. Kapolei, HI Title #ZAC51321	Title or registration issued - New owner reported - Vehicle color noted as Blue
12/20/2022	134,234	American Tire Company Honolulu, HI 808-841-4742 ★ 4.9 / 5.0 68 Verified Reviews ❤️ 48 Customer Favorites	 Vehicle serviced
12/20/2022		Hawaii Motor Vehicle Dept. Kapolei, HI Title #ZAC51321	Title issued or updated - Registration issued or renewed - Vehicle color noted as Blue
06/27/2023	137,524	Oil Changers Kapolei, HI 808-674-8444 https://oilchangers.com/ ★ 4.7 / 5.0 477 Verified Reviews ❤️ 142 Customer Favorites	 Vehicle serviced - Oil and filter changed
09/05/2023		Hawaii Motor Vehicle Dept. Kapolei, HI Title #ZAC51321	Registration issued or renewed - Vehicle color noted as Blue
10/05/2023	140,923	Discount Tire 2 Waipahu, HI 808-797-2878 ★ 4.8 / 5.0 113 Verified Reviews ❤️ 15 Customer Favorites	 Vehicle serviced - Tire(s) balanced - Tire(s) mounted - Tire(s) replaced
12/18/2023	142,650	Midas Waipahu, HI 808-628-6300 midas.com ★ 4.8 / 5.0 365 Verified Reviews ❤️ 365 Customer Favorites	 Vehicle serviced - Maintenance inspection completed

**Owner 6**

Purchased: 2023

Personal Vehicle

Date	Mileage	Source	Comments
12/18/2023		Hawaii Motor Vehicle Dept. Ewa Beach, HI Title #ZAC51323	Title issued or updated - Registration issued or renewed - New owner reported - Vehicle color noted as Blue
06/01/2024	145,594	Discount Tire 2 Waipahu, HI 808-797-2878 ★ 4.8 / 5.0 113 Verified Reviews ❤️ 15 Customer Favorites	 Vehicle serviced - Tire(s) balanced - Tire(s) mounted - Tire(s) replaced

Have Questions? Consumers, please visit our Help Center at www.carfax.com. Dealers or Subscribers, please visit our Help Center at www.carfaxonline.com.



Glossary

Damage Indicator

Damage can be a result of many different types of events. Examples include contact with objects (other cars, trees, traffic signs, road debris, etc), vandalism, or weather-related events. Not every damage event is reported to CARFAX. As details about the damage event become available, those additional details are added to the CARFAX Vehicle History Report. CARFAX recommends that you have this vehicle inspected by a qualified mechanic.

- This CARFAX Vehicle History Report is based only on information supplied to CARFAX and available as of 1/29/26 at 2:56:23 PM (CST). Other information about this vehicle, including problems, may not have been reported to CARFAX. Use this report as one important tool, along with a vehicle inspection and test drive, to make a better decision about your next used car.

Damage Severity

Damage events result in one of the following severity levels:

- Minor: Generally, minor damage is cosmetic (including dents or scratches), may only require reconditioning, and typically does not compromise a vehicle's operation and/or safety.
- Moderate: Moderate damage may affect multiple components of the vehicle and may impair the vehicle's operation and/or safety.
- Severe: Severe damage usually affects multiple components of the vehicle and is likely to compromise the vehicle's operation and/or safety.

CARFAX recommends getting a pre-purchase inspection at a certified collision repair facility.

First Owner

When the first owner(s) obtains a title from a Department of Motor Vehicles as proof of ownership.

New Owner Reported

When a vehicle is sold to a new owner, the Title must be transferred to the new owner(s) at a Department of Motor Vehicles.

Ownership History

CARFAX defines an owner as an individual or business that possesses and uses a vehicle. Not all title transactions represent changes in ownership. To provide estimated number of owners, CARFAX proprietary technology analyzes all the events in a vehicle history. Estimated ownership is available for vehicles manufactured after 1991 and titled solely in the US including Puerto Rico. Dealers sometimes opt to take ownership of a vehicle and are required to in

the following states: Maine, Massachusetts, New Jersey, Ohio, Oklahoma, Pennsylvania and South Dakota. Please consider this as you review a vehicle's estimated ownership history.

Rental

Vehicle was registered by a rental agency.

Title Issued

A state issues a title to provide a vehicle owner with proof of ownership. Each title has a unique number. Each title or registration record on a CARFAX report does not necessarily indicate a change in ownership. In Canada, a registration and bill of sale are used as proof of ownership.

Follow Us:



facebook.com/CARFAX



[@CARFAXinc](https://twitter.com/CARFAXinc)



About CARFAX

CARFAX DEPENDS ON ITS SOURCES FOR THE ACCURACY AND RELIABILITY OF ITS INFORMATION. THEREFORE, NO RESPONSIBILITY IS ASSUMED BY CARFAX OR ITS AGENTS FOR ERRORS OR OMISSIONS IN THIS REPORT. CARFAX FURTHER EXPRESSLY DISCLAIMS ALL WARRANTIES, EXPRESS OR IMPLIED, INCLUDING ANY IMPLIED WARRANTIES OF MERCHANTABILITY OR FITNESS FOR A PARTICULAR PURPOSE.

© 2026 CARFAX, Inc., part of S&P Global. All rights reserved.
1/29/26 2:56:23 PM (CST)

I have reviewed and received a copy of the CARFAX Vehicle History Report for this 2011 MAZDA MAZDA3 vehicle (VIN: JM1BL1UF0B1419421), which is based on information supplied to CARFAX and available as of 1/29/26 at 3:56 PM (EST).

Customer Signature

Date

Dealer Signature

Date